

Clock Radio

AJ 3136

STOP!

Need help? Call us!

Philips representatives are ready to help you with any questions about your new product.

CALL US BEFORE YOU CONSIDER RETURNING THE PRODUCT!

1-800-531-0039

or visit us on the web at www.philips.com

IMPORTANT!
Return your Warranty Registration Card within 10 days
SEE WHY INSIDE



PHILIPS

PHILIPS CONSUMER ELECTRONICS NORTH AMERICA

Knoxville, Tennessee 37914-1810, U.S.A.

English

Français

Español

Meet Philips at the Internet

<http://www.philips.com>

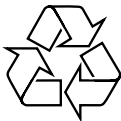

AJ 3136

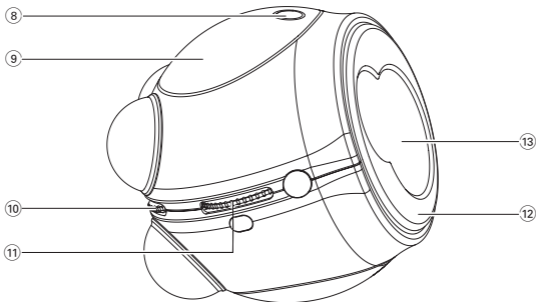
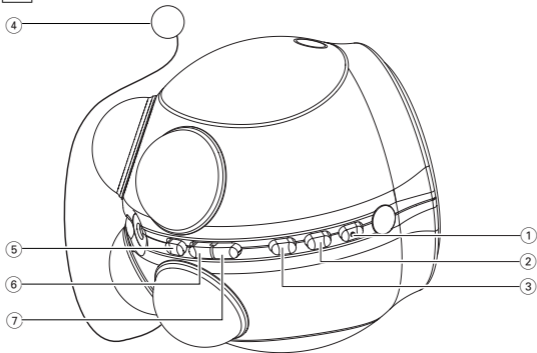

Printed in China

1

ALARM : 🎵



ALARM : 🔔

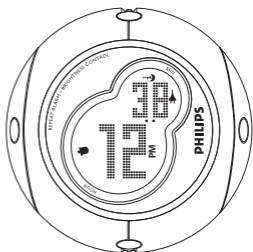

ALARM : 🐱



ALARM : 🚗

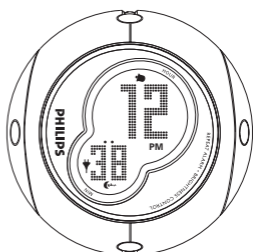

SAFETY

Know these *safety* symbols



This “bolt of lightning” indicates uninsulated material within your unit may cause an electrical shock. For the safety of everyone in your household, please do not remove product covering.



The “exclamation point” calls attention to features for which you should read the enclosed literature closely to prevent operating and maintenance problems.

WARNING: TO PREVENT FIRE OR SHOCK HAZARD, DO NOT EXPOSE THIS EQUIPMENT TO RAIN OR MOISTURE.

CAUTION: To prevent electric shock, match wide blade of plug to wide slot, and fully insert.

IMPORTANT SAFETY INSTRUCTIONS

1. **Read these instructions.**
2. **Keep these instructions.**
3. **Heed all warnings.**
4. **Follow all instructions.**
5. **Do not use this apparatus near water.**
6. **Clean only with dry cloth.**
7. **Do not block any ventilation openings. Install in accordance with the manufacturer's instructions.**
8. **Do not install near any heat sources** such as radiators, heat registers, stoves, or other apparatus (including amplifiers) that produce heat.
9. **Only use attachments/accessories** specified by the manufacturer.

10.



Use only with the cart, stand, tripod, bracket, or table specified by the manufacturer or sold with the apparatus. When a cart is used, use caution when moving the cart/apparatus combination to avoid injury from tip-over.

11. **Refer all servicing** to qualified service personnel. Servicing is required when the apparatus has been damaged in any way, such as power-supply cord or plug is damaged, liquid has been spilled or objects have fallen into the apparatus, the apparatus has been exposed to rain or moisture, does not operate normally, or has been dropped.
12. **Battery usage CAUTION** – To prevent battery leakage which may result in bodily injury, property damage, or damage to the unit:
 - Install **all** batteries correctly, **+** and **-** as marked on the unit.
 - Do not mix batteries (**old** and **new** or **carbon** and **alkaline**, etc.).
 - Remove batteries when the unit is not used for a long time.

LIMITED WARRANTY

PORTABLE AUDIO

90 days Free Exchange

This product must be carried in for an exchange.

WHO IS COVERED?

You must have proof of purchase to exchange the product. A sales receipt or other document showing that you purchased the product is considered proof of purchase. Attach it to this owner's manual and keep both nearby.

WHAT IS COVERED?

Warranty coverage begins the day you buy your product. For 90 days thereafter, a defective or inoperative product will be replaced with a new, renewed or comparable product at no charge to you. A replacement product is covered only for the original warranty period. When the warranty on the original product expires, the warranty on the replacement product also expires.

WHAT IS EXCLUDED?

Your warranty does not cover:

- labor charges for installation or setup of the product, adjustment of customer controls on the product, and installation or repair of antenna systems outside of the product.
- product repair and/or part replacement because of misuse, accident, unauthorized repair or other cause not within the control of Philips.
- reception problems caused by signal conditions or cable or antenna systems outside the unit.

- a product that requires modification or adaptation to enable it to operate in any country other than the country for which it was designed, manufactured, approved and/or authorized, or repair of products damaged by these modifications.
- incidental or consequential damages resulting from the product. (Some states do not allow the exclusion of incidental or consequential damages, so the above exclusion may not apply to you. This includes, but is not limited to, prerecorded material, whether copyrighted or not copyrighted.)
- a product used for commercial or institutional purposes.

WHERE IS EXCHANGE AVAILABLE?

You may exchange the product in all countries where the product is officially distributed by Philips. In countries where Philips does not distribute the product, the local Philips service organization will attempt to provide a replacement product (although there may be a delay if the appropriate product is not readily available).

BEFORE REQUESTING EXCHANGE...

Please check your owner's manual for assistance. If you have additional questions, call us at 1-800-531-0039.

LIMITED WARRANTY

EXCHANGING A PRODUCT IN U.S.A., PUERTO RICO, OR U.S. VIRGIN ISLANDS...

Contact 1-800-531-0039 to arrange an exchange. Or, ship the product, insured and freight prepaid, and with proof of purchase enclosed, to the address listed below.

Philips Exchange Program
Suite A
406 North Irish Street
Greenville TN 37745

(In U.S.A., Puerto Rico, and U.S. Virgin Islands, all implied warranties, including implied warranties of merchantability and fitness for a particular purpose, are limited in duration to the duration of this express warranty. But, because some states do not allow limitations on how long an implied warranty may last, this limitation may not apply to you.)

EXCHANGING A PRODUCT IN CANADA...

Please contact Philips at:

1-800-661-6162 (French Speaking)
1-800-531-0039 (English or Spanish Speaking)

(In Canada, this warranty is given in lieu of all other warranties. No other warranties are expressed or implied, including any implied warranties of merchantability or fitness for a particular purpose. Philips is not liable under any circumstances for any direct, indirect, special, incidental or consequential damages, howsoever incurred, even if notified of the possibility of such damages.)

REMEMBER...

Please record below the model and serial numbers found on the product. Also, please fill out and mail your warranty registration card promptly. It will be easier for us to notify you if necessary.

MODEL # _____

SERIAL # _____

This warranty gives you specific legal rights. You may have other rights which vary from state/province to state/province.

Philips, P.O. Box 520890, Miami, FL 33152, USA, (402) 536-4171

EL4966E007 / 8-02

CONTROLS (see 1)

① ALARM RESET / SLEEP

- stops active alarm for 24 hours
- activates the radio for sleep function, and to select the sleep time

② ALARM ON / OFF : switches alarm ON and OFF

③ RADIO ON / OFF - switches radio ON and OFF

④ Pigtail aerial - antenna for FM reception

⑤ SET AL / TIME- sets the clock and alarm time

⑥ MIN + : - adjusts the minutes for clock and alarm times

⑦ HOUR + : adjusts the hours for clock and alarm times

⑧ Battery door - opens to store a 4 x R6/UM3/AA batteries (not included)

⑨ RESET - press if the set / display does not react to operation of any button

⑩ VOLUME - adjusts the sound level

⑪ TUNING - tunes to radio stations

⑫ REPEAT ALARM•BRIGHTNESS CONTROL

- switches off the alarm for a 5 minute period
- changes display illumination brightness
- stops SLEEP function

⑬ Display - shows clock and alarm times and status

The model and serial number are located inside the battery compartment.

POWER SUPPLY

Batteries (not included)

- 1 Open battery door and insert four batteries (preferably PHILIPS POWER LIFE or alkaline), type R6, UM3 or AA as indicated in the compartment.
- 2 Remove the batteries from the set if they are exhausted or not be used for a long time.
 - When the batteries are turning low,  appears in the display. The radio and backlight will not function, but the display and power saving buzzer will continue to operate.
 - When replacing batteries, the clock time and alarm setting will be stored by the self-powered back-up for 1 minute (see 'Self-Powered Back-Up').
 - Make sure the radio is switched off to save battery energy.

Batteries contain chemical substances, so they should be disposed of properly.

SELF-POWERED BACK-UP

The self-powered back-up conveniently allows your clock and alarm settings to be stored for up to 1 minute when there is a power interruption e.g. AC power failure or when changing batteries.

The complete clock radio and backlight illumination will be switched off. As soon as the power supply returns the display will indicate the correct time.

- If power supply returns after 1 minute, the demo mode appears and you will need to re-enter the clock and alarm setting.

BATTERY LOW MODE

If you have inserted batteries, the battery low indicator  lights up when:

- battery power is low.

During the battery low mode, both Radio/Sleep, sound effects, backlight will not function.

Operation of any alarm mode (Radio/Buzzer/Submarine/Frog) automatically changes to a slow buzzer beep frequency.

- If the **RADIO ON / OFF, ALARM RESET / SLEEP** or **REPEAT ALARM•BRIGHTNESS CONTROL** button is pressed, the battery low indicator will flash for 5 seconds and then remains non-blinking.

GENERAL FEATURES

Reset

Should you receive external interference e.g. static electricity from carpets, thunderstorms, etc. Which affects the display and electronic functions of your set, RESET allows you to clear all previous settings and start up again.

- Use a ballpoint pen to press **RESET**, found inside battery compartment.

Demo mode

When the set is first connected to a power supply or has been reset, 'PHILIPS' will scroll continuously across the demonstration display.

- Press **SET AL / TIME** to exit the demo mode, before you set the times or press **RADIO ON / OFF** or **ALARM RESET / SLEEP** to switch on the Radio.

Illumination brightness

Press **REPEAT ALARM•BRIGHTNESS CONTROL** once or more.

- The brightness of the display will change in this sequence:
off \Rightarrow **bright (5 seconds)** \Rightarrow **OFF** (for batteries)

Note:

When the alarm or SLEEP function is active, the brightness cannot be adjusted.

SETTING THE CLOCK AND ALARM TIMES

The time is displayed using the 12-hour clock with PM indicator (PM off = AM).

Setting the clock time

1. Press **SET AL / TIME** twice within a second to enter the clock time setting mode.
→ The clock time display flashes and you will hear a short beep.
2. Hold down or press **HOUR +** or **MIN +** repeatedly to set and adjust the hours and minutes respectively. Release **HOUR +** or **MIN +** when you have reached the correct setting.
3. After both the hours and minutes are set, press **SET AL / TIME** to confirm the setting.
→ You will hear two short beeps.



Setting the alarm time

1. Press **SET AL / TIME** once to enter the alarm time setting mode.
→  lights up and the alarm time display flashes. You will hear a short beep.
 2. Hold down or press **HOUR +** or **MIN +** repeatedly to set and adjust the hours and minutes respectively. Release **HOUR +** or **MIN +** when you have reached the correct setting.
 3. After both the hours and minutes are set, press **SET AL / TIME** to confirm the setting.
→ You will hear two short beeps.
→ Display returns to clock time.
- Time setting is also automatically confirmed after 10 seconds after you set the time.
 - It is not possible to adjust the alarm time during an alarm call or the repeat alarm mode.

RADIO (FM only)





- 1 Press **RADIO ON / OFF** once to switch on the radio.
→ Display shows 'ON' shortly.
- 2 Adjust **TUNING** to find your radio station.
- 3 Adjust the sound using **VOLUME**.
- 4 Press **RADIO ON / OFF** to switch off.

To improve reception:

- Extend and position the pigtail fully to obtain optimum reception.

USING THE ALARM

General (see [2](#))

If you wish to use the alarm, first set the alarm time before selecting your choice of alarm mode. By rotating the set in 4 different position, you can choose Radio (FM)  / Buzzer  / Submarine  / Frog  to wake you up.

As you rotate the set, AJ3136 interacts in the following way. You will :

- hear a special whirring sound effect
- see the backlight blink briefly.

The hour and minute display will also adjust to match the new rotated position.

TIP :

- If you wish to deactivate or activate the whirring sound, press and hold on the **HOURL +** and **RADIO ON / OFF** buttons simultaneously.
- When the batteries on AJ3136 are low, the battery low icon  blinks. No backlight and sound effects are possible.

Setting the alarm

1. Press **ALARM ON / OFF** once to switch on the alarm.
→  lights up.
2. Rotate the set with the symbol of the alarm mode, which you wish to be woke up, facing on the top.

When reach alarm setting time, Radio, Buzzer, Submarine or Frog will switch on for about 30 minutes and the alarm indicator flashes.

- For Buzzer option only, your gentle wake alarm increases its beep tone frequency within seconds.

Switching off the alarm

24HR ALARM RESET

If you want the alarm mode to be stopped immediately but also wish to retain the same alarm setting for the following day:

- Press **ALARM RESET / SLEEP**.
→ You will hear a sound “Ding Dong” confirming 24 hour reset activation.

REPEAT ALARM

This will repeat your alarm call at 5 minute intervals.

- During the alarm call, press **REPEAT ALARM•BRIGHTNESS CONTROL**
→ The alarm indicator flashes during repeat alarm.
- Repeat if desired.

CANCELING THE ALARM COMPLETELY



- During alarm activated or repeat alarm mode, press **ALARM ON / OFF** once. Alarm will be switched off completely.
→ The alarm indicator disappears.

SLEEP

About Sleep

This set has a built-in sleep timer, which enables the radio to be automatically switched off after a set period of time. There are four sleep time options.

Setting and switching off sleep

- 1 Press **ALARM RESET / SLEEP** to switch on the radio
- 2 Within 1 second, press **ALARM RESET / SLEEP** again once or more to select your sleep time.
 - The sleep time options:
SL : 30, SL : 20, SL : 10 and **OFF**.
→ The Sleep indicator  lights up.
- 3 To cancel sleep, press either:
 - **ALARM RESET / SLEEP** once or more until  disappears from the display.
 - **REPEAT ALARM•BRIGHTNESS CONTROL**

MAINTENANCE

- If you do not intend to use set for a long time, remove the batteries.
- Do not expose the set to humidity, rain, sand or excessive heat caused by heating equipment or direct sunlight.
- To clean your set, use a soft damp cloth or chamois leather. Do not use cleaning products, which contain benzene, thinner, etc. as these may harm the housing.

ENVIROMENTAL INFORMATION

We have reduced the packaging to its minimum using only paper and cardboard. Your set consists of materials which can be recycled if disassembled by a specialized company. **Please observe local regulations to dispose of packing materials, exhausted batteries and old equipment.**

TROUBLESHOOTING

If a fault occurs, first check the points listed below before taking the set for repair. If you are unable to remedy a problem by following these hints, consult your dealer or service center.

WARNING: *Under no circumstances should you try to repair the set yourself, as this will invalidate the warranty. Do not open the set as there is a risk of electric shock!*

No sound

- Volume not adjusted
- Adjust the VOLUME

No display backlight / display malfunction/ radio and alarm do not function

- Set is in Power Low mode
- Insert fresh batteries

Display error / no reaction to any controls

- Electrostatic discharge
- Press the **RESET** hole inside battery compartment of the set with a ballpoint pen.

Intermittent crackling sound during FM reception

- Weak signal
- Extend and position the pigtail aerial

The alarm does not function

- Alarm time/ mode not set
- See **SETTING THE ALARM TIME**
- Volume too low for radio
- Increase the volume
- RADIO not tuned to a radio station
- Tune to a station

Rattling sound. Is something loose ?

No. You will hear a slight rattling sound if you shake the set. This is perfectly normal as the AJ3136 uses a special contact device inside the set to detect rotation.

The set complies with the FCC-Rules, Part 15.

Operation is subject to the following two conditions:

- 1. This device may not cause harmful interference, and*
- 2. This device must accept any interference received, including interference that may cause undesired operation.*